

### General Description

This planar stripe MOSFET has better characteristics, such as fast switching time, low on resistance, low gate charge and excellent avalanche characteristics. It is mainly suitable for LED Lighting and switching mode power supplies.

### FEATURES

- $V_{DSS(Min.)} = 200V$ ,  $I_D = 1A$
- Drain-Source ON Resistance :  $R_{DS(ON)} = 1.05$  (max) @  $V_{GS} = 10V$
- $Q_g(typ.) = 2.9nC$
- $V_{th(Max.)} = 2V$

### MAXIMUM RATING (Tc=25 )

CHARACTERISTIC	SYMBOL	RATING	UNIT	
Drain-Source Voltage	$V_{DSS}$	200	V	
Gate-Source Voltage	$V_{GSS}$	$\pm 20$	V	
Drain Current	@T <sub>C</sub> =25	1*	A	
	@T <sub>C</sub> =100	0.6*		
	Pulsed (Note1)	I <sub>DP</sub>		4*
Single Pulsed Avalanche Energy (Note 2)	E <sub>AS</sub>	52	mJ	
Repetitive Avalanche Energy (Note 1)	E <sub>AR</sub>	0.2	mJ	
Peak Diode Recovery dv/dt (Note 3)	dv/dt	5.5	V/ns	
Drain Power Dissipation	T <sub>A</sub> =25	P <sub>D</sub>	2.2*	W
	Derate above 25		0.018	W/
Maximum Junction Temperature	T <sub>j</sub>	150		
Storage Temperature Range	T <sub>stg</sub>	-55 150		
<b>Thermal Characteristics</b>				
Thermal Resistance, Junction-to-Ambient	R <sub>thJA</sub>	57*	/W	

\* : Surface Mounted on FR4 Board (40mm × 40mm, 1.0t)

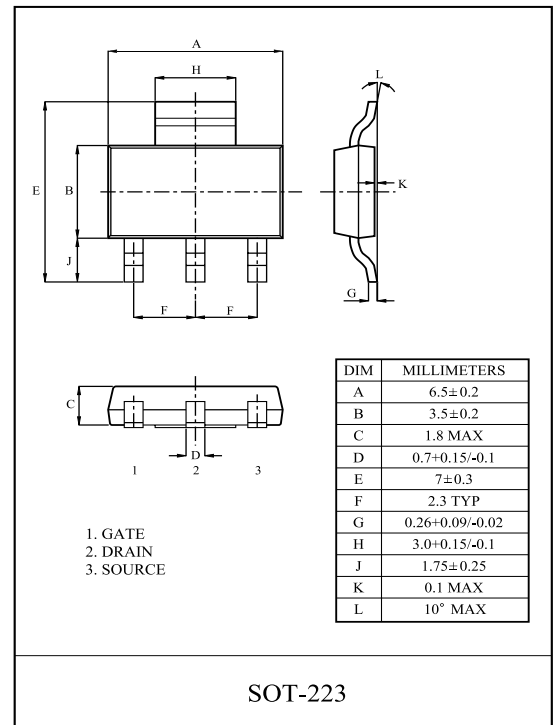

### PIN CONNECTION

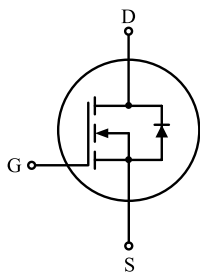

# KF4N20LW

## ELECTRICAL CHARACTERISTICS (Tc=25 )

CHARACTERISTIC	SYMBOL	TEST CONDITION	MIN.	TYP.	MAX.	UNIT
<b>Static</b>						
Drain-Source Breakdown Voltage	$BV_{DSS}$	$I_D=250\ \mu A, V_{GS}=0V$	200	-	-	V
Breakdown Voltage Temperature Coefficient	$BV_{DSS}/T_j$	$I_D=250\ \mu A$ , Referenced to 25	-	0.2	-	V/
Drain Cut-off Current	$I_{DSS}$	$V_{DS}=200V, V_{GS}=0V$ ,	-	-	10	$\mu A$
Gate Threshold Voltage	$V_{th}$	$V_{DS}=V_{GS}, I_D=250\ \mu A$	1.0	-	2.0	V
Gate Leakage Current	$I_{GSS}$	$V_{GS}=\pm 20V, V_{DS}=0V$	-	-	$\pm 100$	nA
Drain-Source ON Resistance	$R_{DS(ON)}$	$V_{GS}=10V, I_D=0.5A$	-	0.85	1.05	
		$V_{GS}=5V, I_D=0.5A$		0.89	1.10	
<b>Dynamic</b>						
Total Gate Charge	$Q_g$	$V_{DS}=150V, I_D=3.6A$ $V_{GS}=5V$ (Note4,5)	-	2.9	3.8	nC
Gate-Source Charge	$Q_{gs}$		-	0.6	-	
Gate-Drain Charge	$Q_{gd}$		-	2.2	-	
Turn-on Delay time	$t_{d(on)}$	$V_{DD}=100V, I_D=3.6A$ $R_G=25$ (Note4,5) $V_{GS}=5V$	-	10	-	ns
Turn-on Rise time	$t_r$		-	20	-	
Turn-off Delay time	$t_{d(off)}$		-	15	-	
Turn-off Fall time	$t_f$		-	15	-	
Input Capacitance	$C_{iss}$	$V_{DS}=25V, V_{GS}=0V, f=1.0MHz$	-	170	220	pF
Output Capacitance	$C_{oss}$		-	25	-	
Reverse Transfer Capacitance	$C_{rss}$		-	4.0	-	
<b>Source-Drain Diode Ratings</b>						
Continuous Source Current	$I_S$	$V_{GS}<V_{th}$	-	-	1	A
Pulsed Source Current	$I_{SP}$		-	-	4	
Diode Forward Voltage	$V_{SD}$	$I_S=1A, V_{GS}=0V$	-	-	1.4	V
Reverse Recovery Time	$t_{rr}$	$I_S=3.6A, V_{GS}=0V$ , $dI_S/dt=100A/\mu s$	-	100	-	ns
Reverse Recovery Charge	$Q_{rr}$		-	0.30	-	$\mu C$

Note 1) Repetivity rating : Pulse width limited by junction temperature.

Note 2)  $L = 78mH, I_S=1A, V_{DD}=50V, R_G = 25$  , Starting  $T_j = 25$  .

Note 3)  $I_S = 2A, dI/dt = 300A/\mu s, V_{DD} = BV_{DSS}$ , Starting  $T_j = 25$  .

Note 4) Pulse Test : Pulse width  $300\mu s$ , Duty Cycle  $2\%$ .

Note 5) Essentially independent of operating temperature.

### Marking

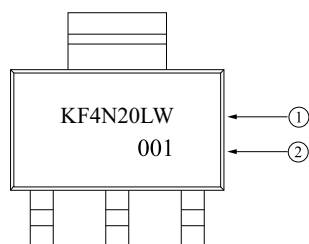

① PRODUCT NAME

② LOT NO

# KF4N20LW

Fig1.  $I_D - V_{DS}$

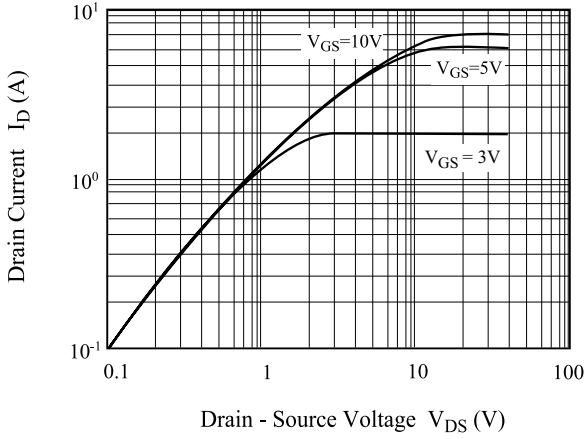

Fig2.  $I_D - V_{GS}$

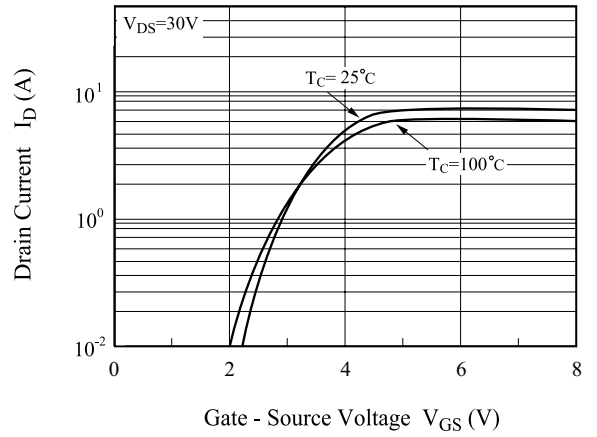

Fig3.  $BV_{DSS} - T_j$

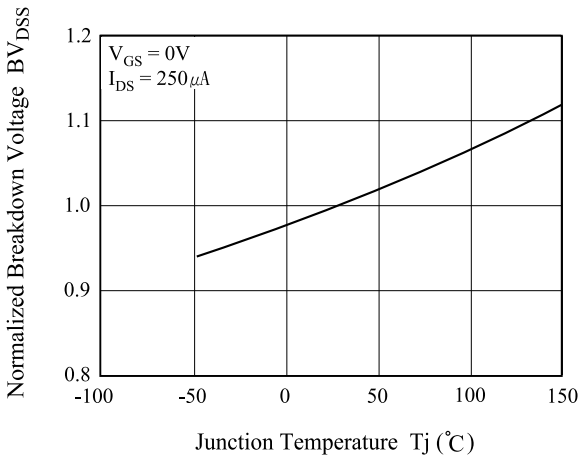

Fig4.  $R_{DS(ON)} - I_D$

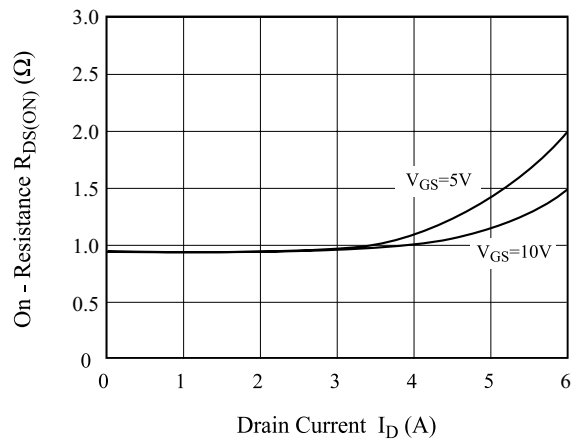

Fig5.  $I_S - V_{SD}$

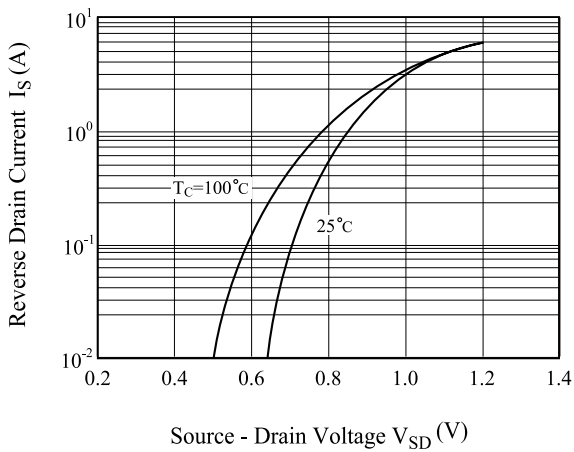
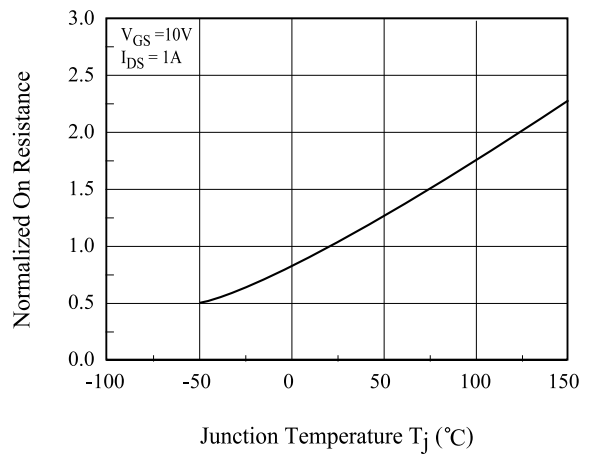

Fig6.  $R_{DS(ON)} - T_j$



# KF4N20LW

Fig 7. C - V<sub>DS</sub>

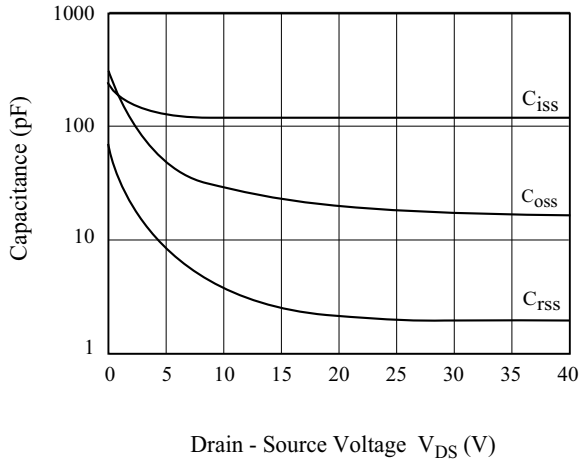

Fig8. Q<sub>g</sub>- V<sub>GS</sub>

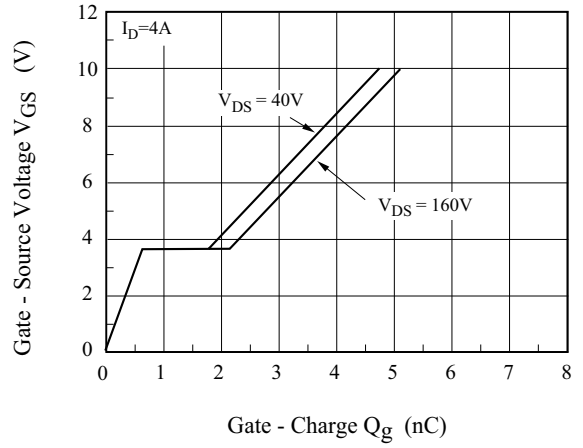

Fig9. Safe Operation Area

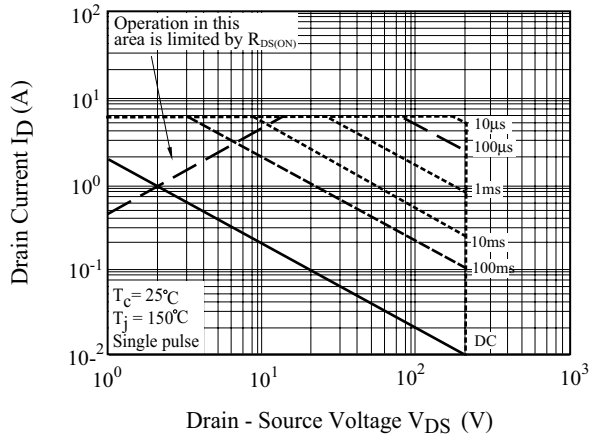

Fig10. I<sub>D</sub> - T<sub>j</sub>

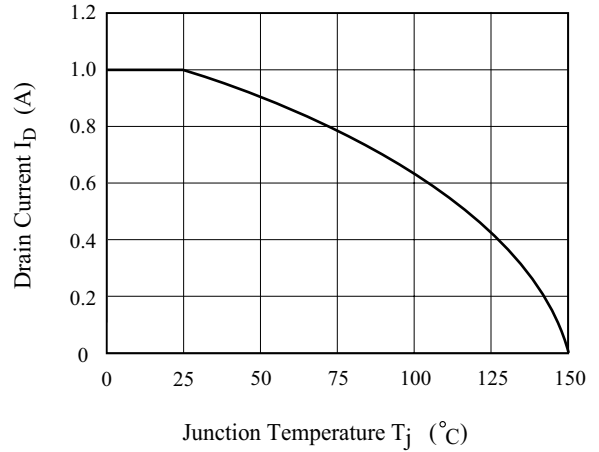

Fig11. Transient Thermal Response Curve

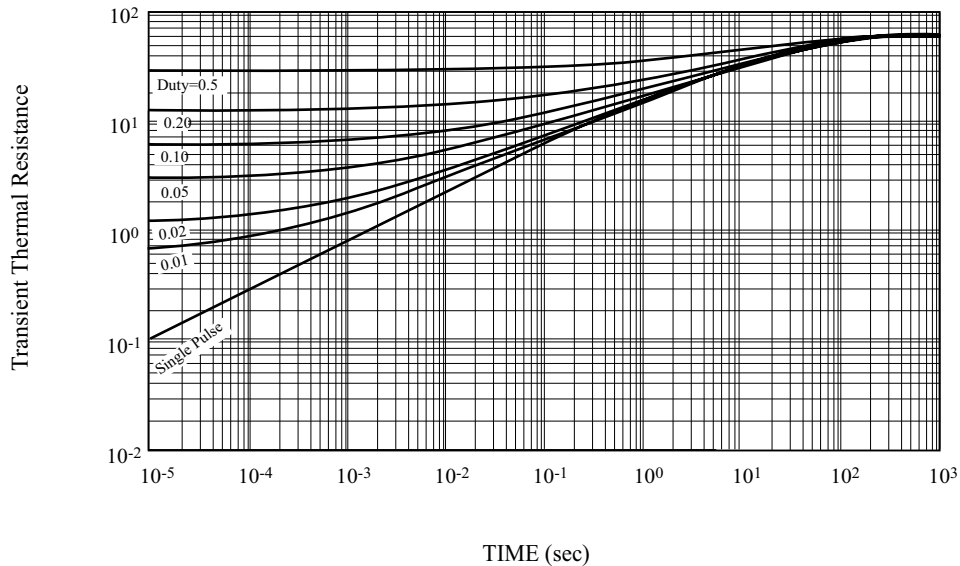

Fig12. Gate Charge

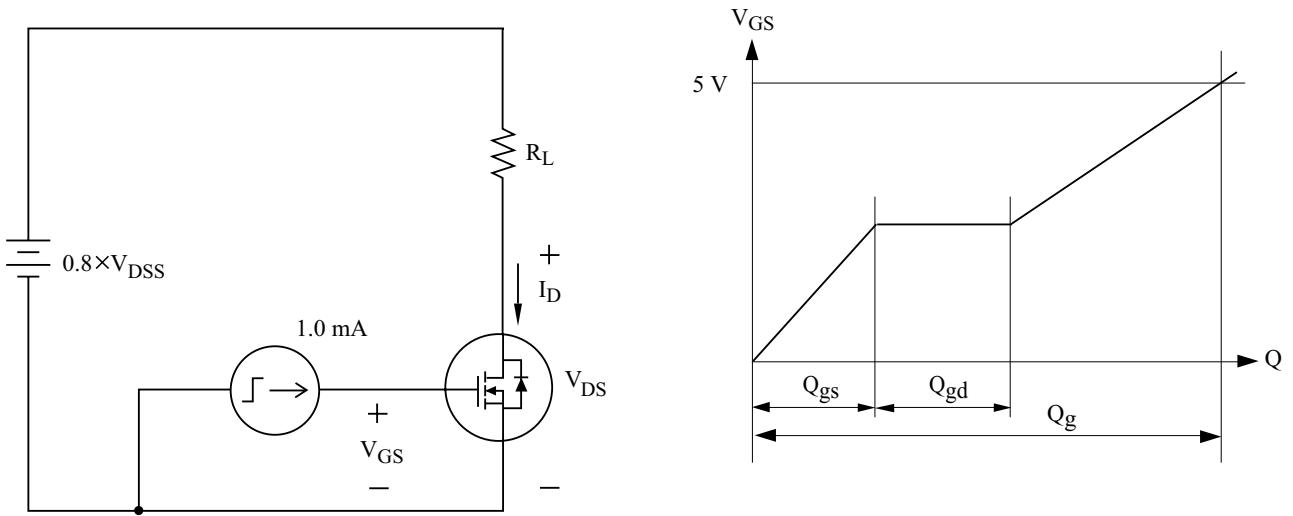

Fig13. Single Pulsed Avalanche Energy

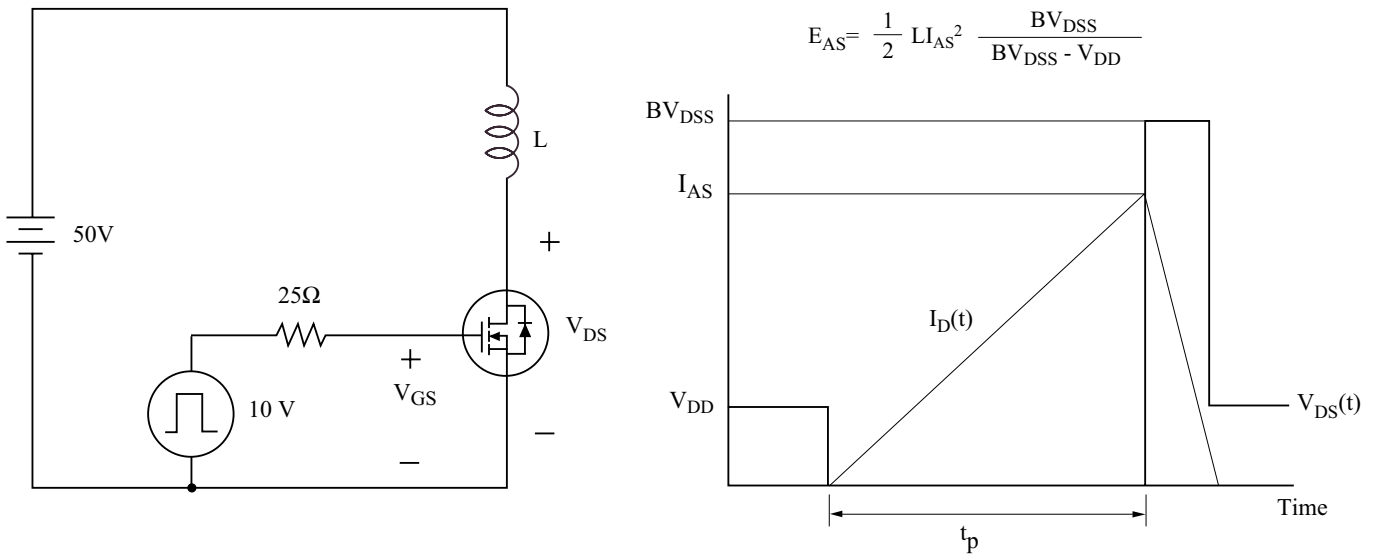

Fig14. Resistive Load Switching

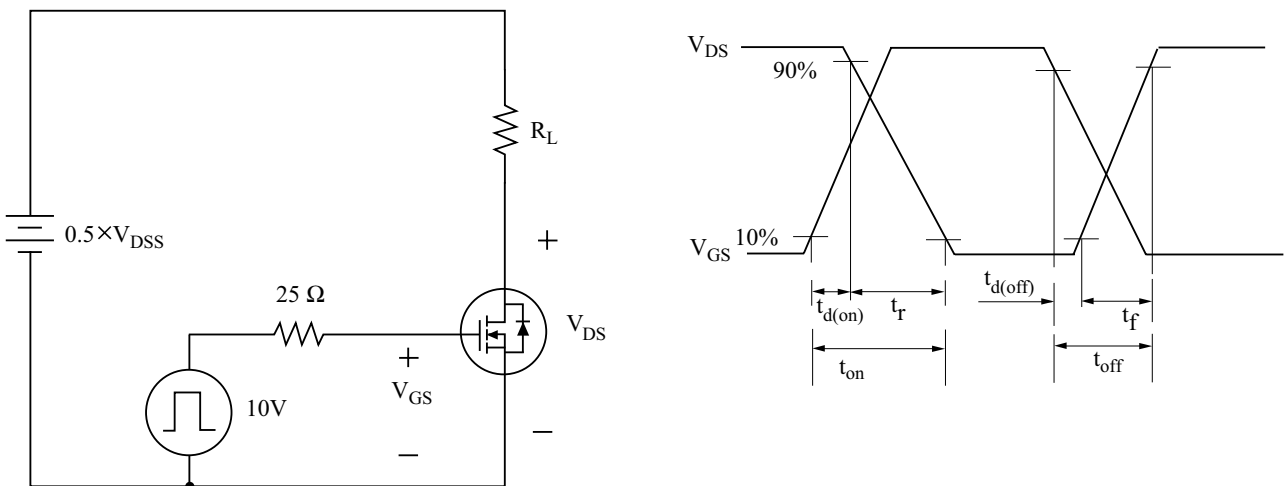

Fig15. Source - Drain Diode Reverse Recovery and  $dv/dt$

